

HEADERS

SJS Stair and
Millwork LLC
Englewood CO

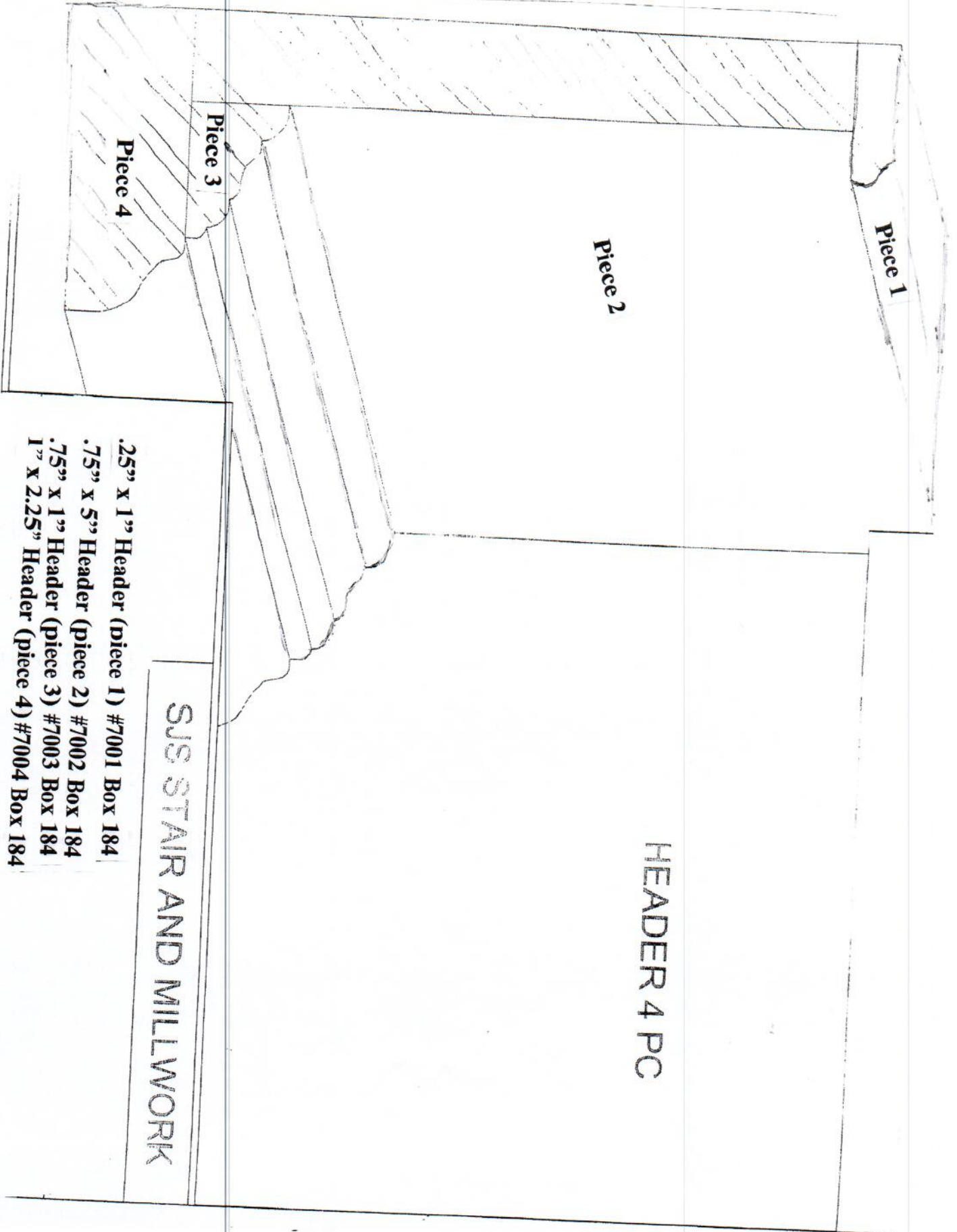

Piece 1

Piece 2

Piece 3

Piece 4

HEADER 4 PC

SJS STAIR AND MILLWORK

- .25" x 1" Header (piece 1) #7001 Box 184
- .75" x 5" Header (piece 2) #7002 Box 184
- .75" x 1" Header (piece 3) #7003 Box 184
- 1" x 2.25" Header (piece 4) #7004 Box 184

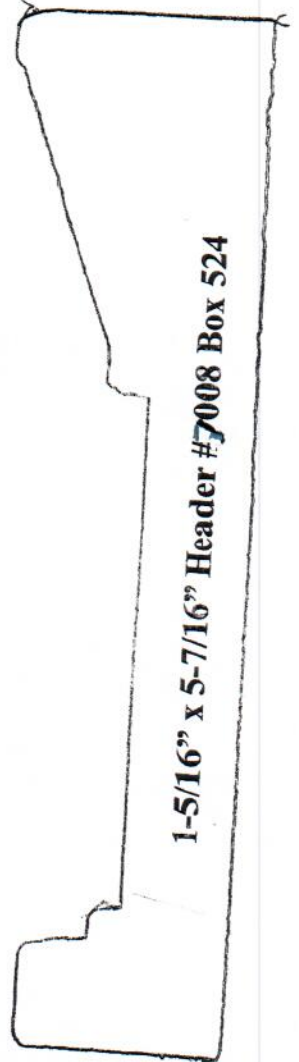
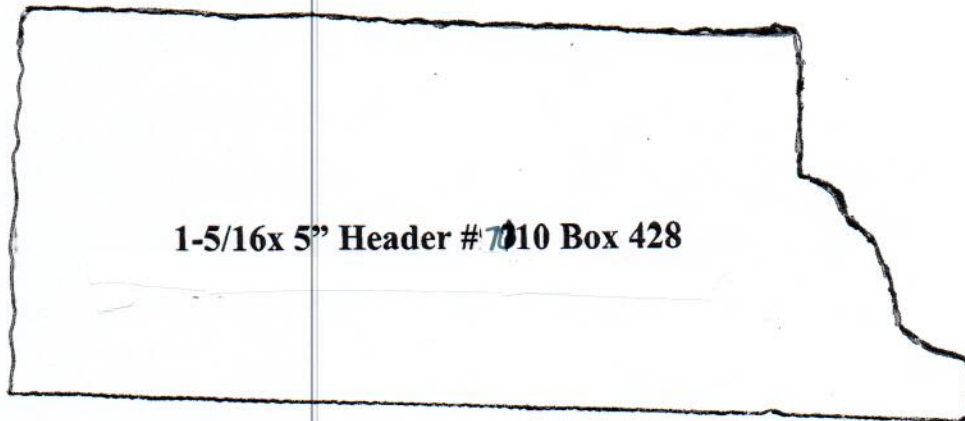
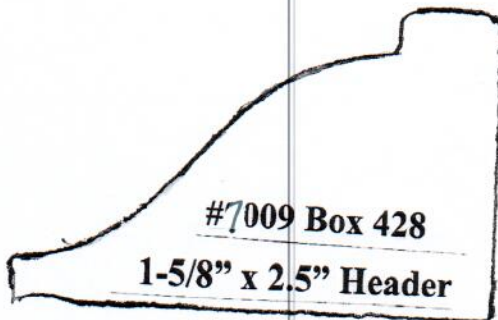
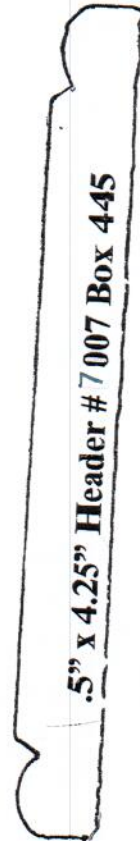
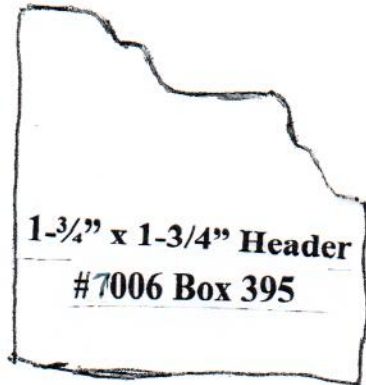
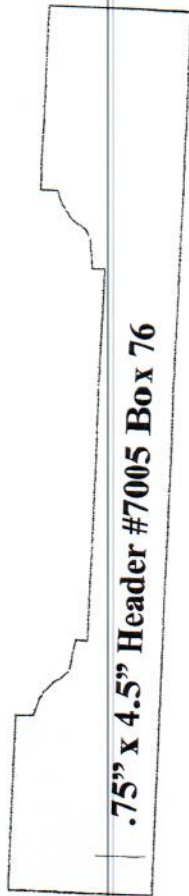

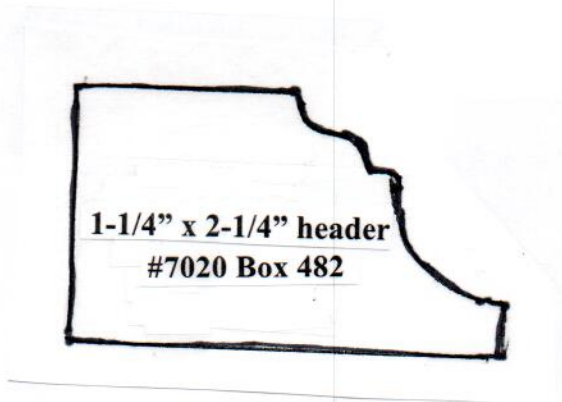
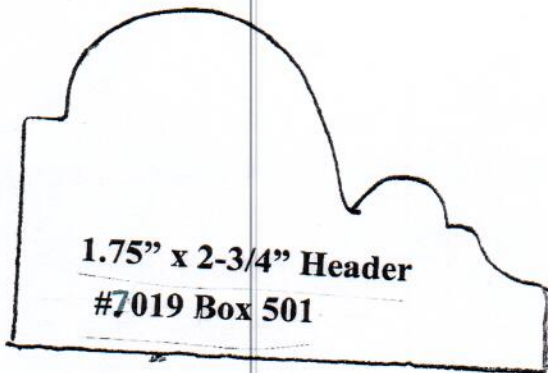
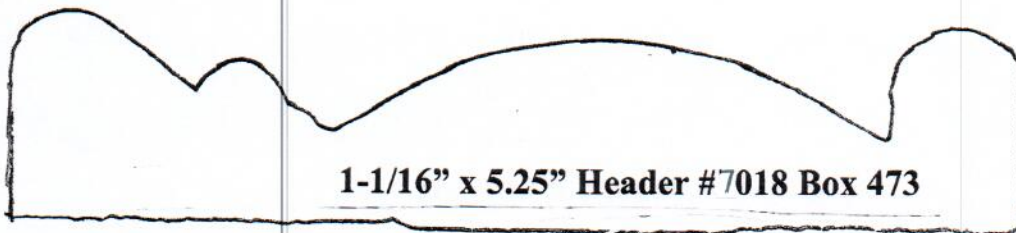
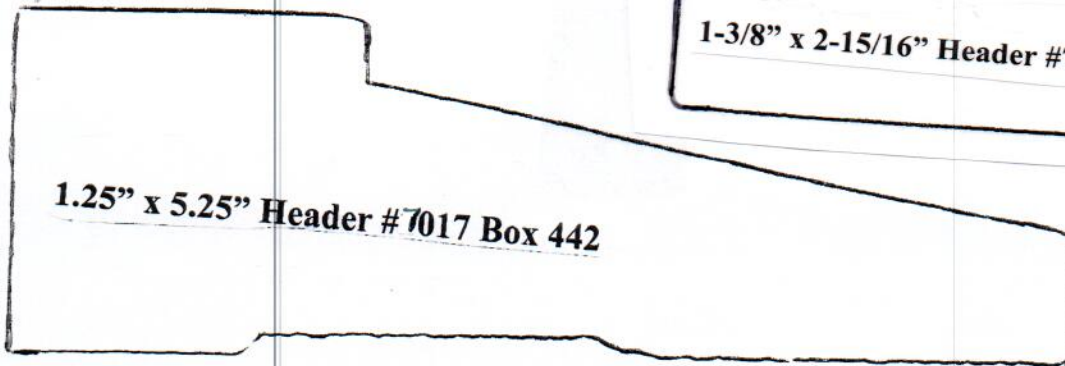
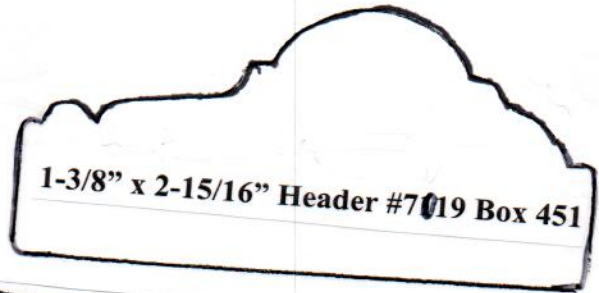
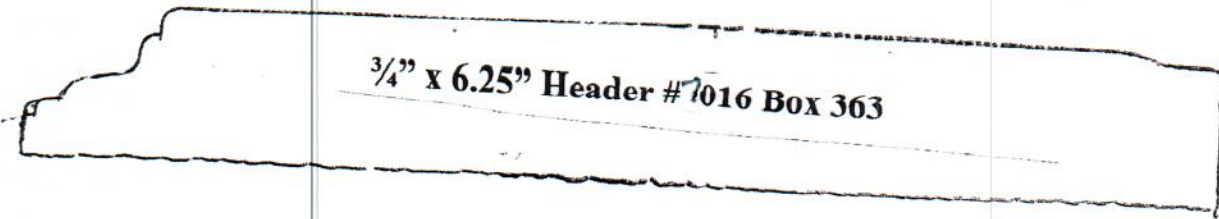

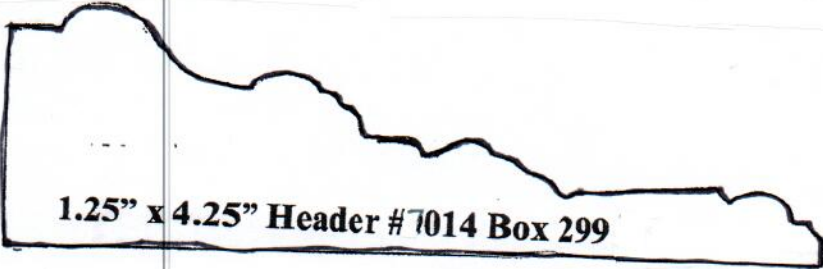
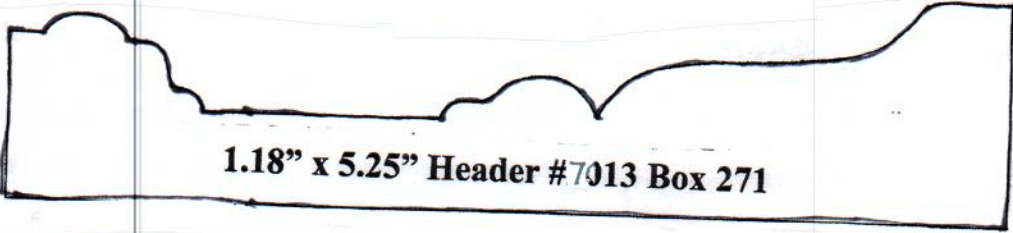
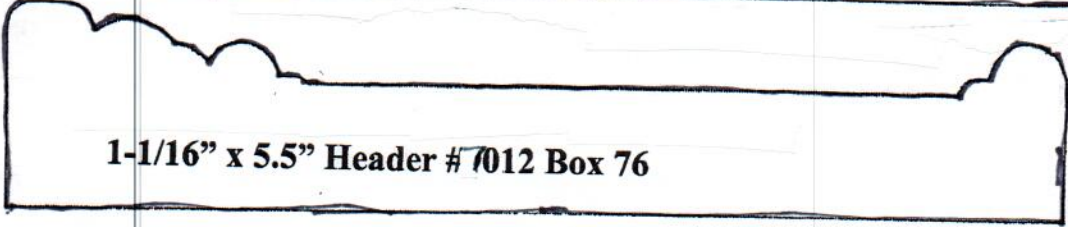
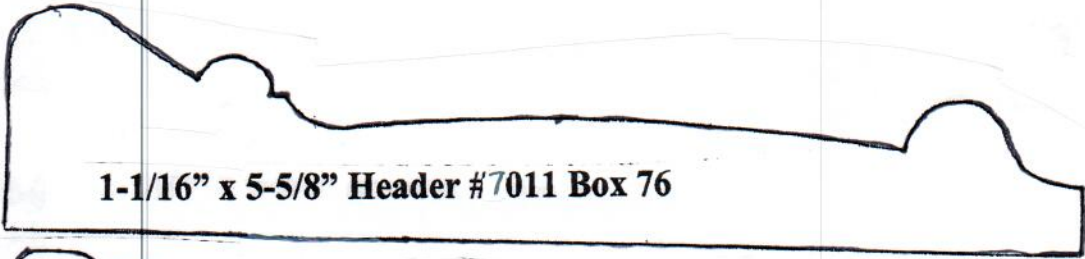

1.25" x 2.5" Header

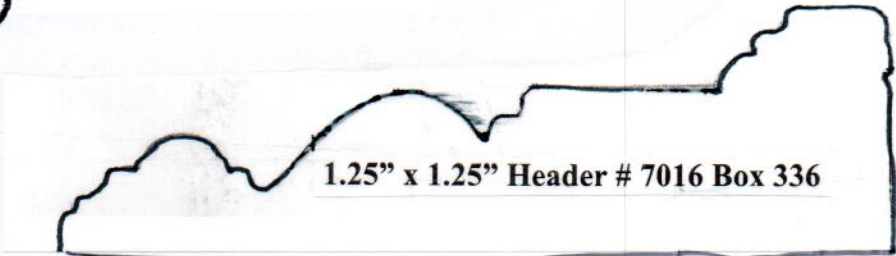
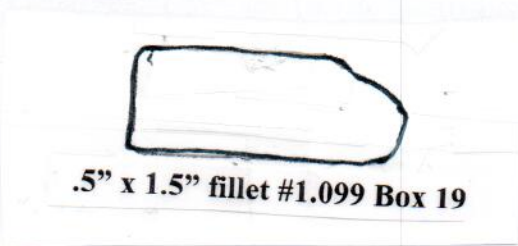
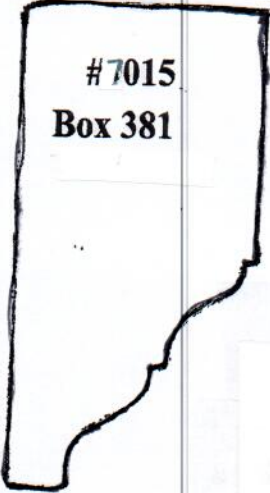

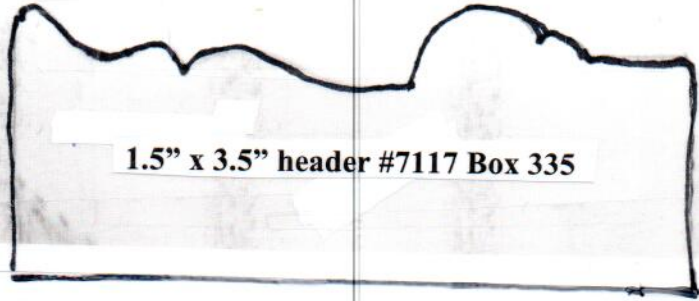

1.5" x 3.5" header #7117 Box 335



3/8" x 1.25" fillet & cove #1.159 Box 496

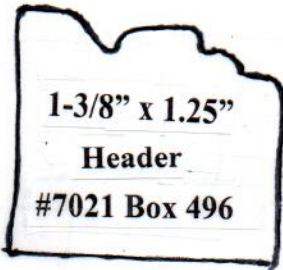

1-3/8" x 1.25"
Header
#7021 Box 496



9/16" x 1-1/16" fillet #
1.172 Box 534 .50Ax



.5" x 1.25" fillet & cove #1.160 Box 496

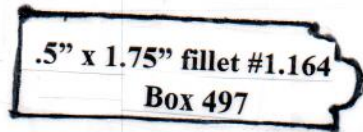

.5" x 1.75" fillet #1.164
Box 497

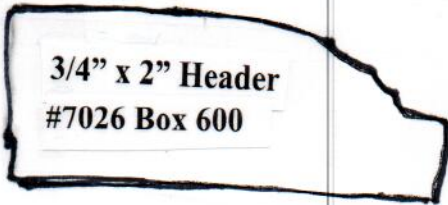

3/4" x 2" Header
#7026 Box 600

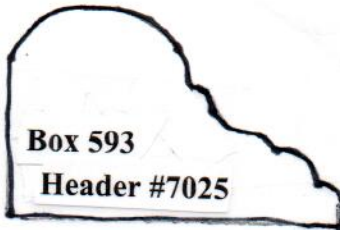

Box 593
Header #7025

1-1/16" x 1-11/16"

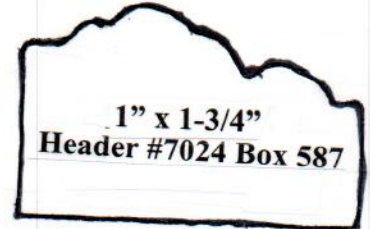

1" x 1-3/4"
Header #7024 Box 587

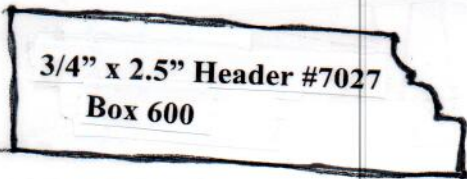

3/4" x 2.5" Header #7027
Box 600

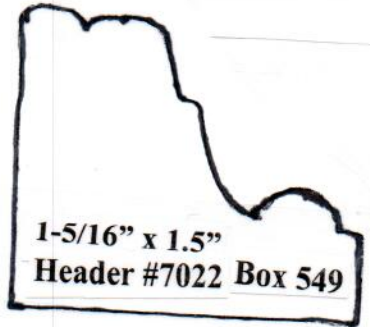

1-5/16" x 1.5"
Header #7022 Box 549

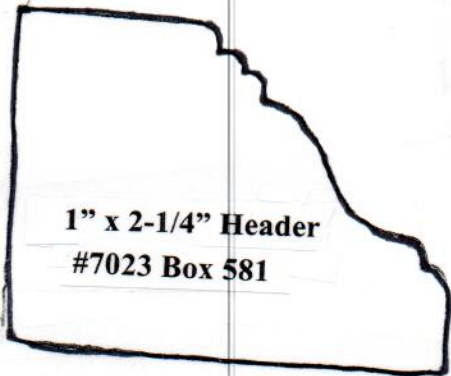

1" x 2-1/4" Header
#7023 Box 581

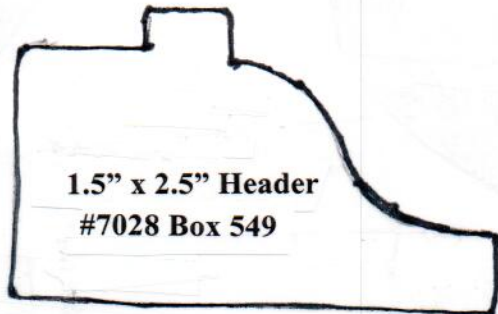

1.5" x 2.5" Header
#7028 Box 549

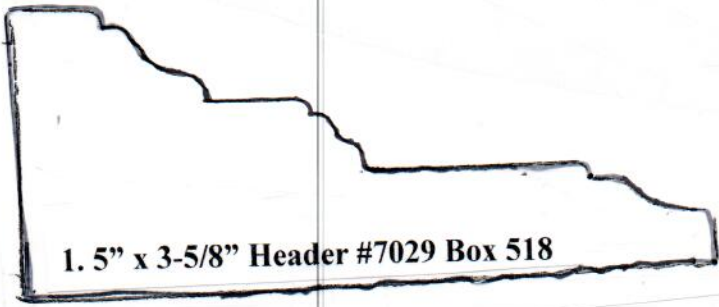

1.5" x 3-5/8" Header #7029 Box 518

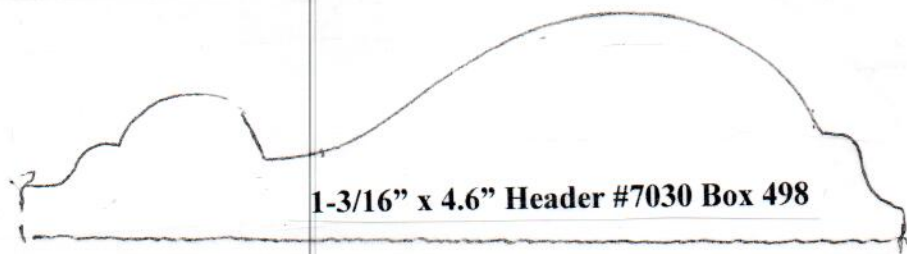

1-3/16" x 4.6" Header #7030 Box 498